

Mil e Yon Nwit Syantifik Yo

1

1

Pa
Jean-Pierre
Polit



Se te yon fwa yon Sultan arab ki te abite nan yon mayifik palais, nan limit l'oryan. Li te gen tout bagay, lò, fanm, anpil cheval mayifik. Men chak swa li pa't ka dòmi, paske li t'ap poze tèt tout sòt de kesyon ke li pa't ka jwenn repons yo. Chak maten, li te konn konvoke Schatzmani, gran Vizi li a.





Sa kse. Chatzmani vle'm mouri. Jwenn yon objè konsa enposib paske li pa egziste. Si mwen siye braslè sa daprè liy mitan li, m'ap jwenn de silend, men pa yon sèl band.

Mwen volé nan tout rwayòm nan e mwen pat wè anyen ki ka sanble ak sa vizi Chatzmani te mande'w la, mèt ou.



Se sa menm

Twazièm jou, fatal la rive



Men, Aléthéa, lannwit pral tonbe. Demen, byen bonè, Chatzmani pral fè yo coupe tèt mwen. Kisa pou'm fè entre tan. Lafwa, mwen t'ap astike kwiv yo. Mwen dwe jis kontinye.

pa Allah, tank lamp sa sal, tou rouye. Li ta dwe fwote sèk si'm vle fè'l briye



E Anselme Lanturlu fwote lanp la...



A, yon ti le, anfen!..

pa profèt la kiyès ou ye?!?

Miah!

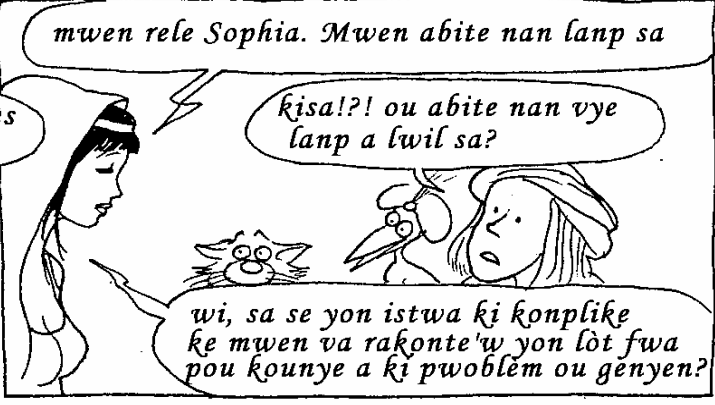

mwen rele Sophia. Mwen abite nan lanp sa

kisa?! ou abite nan vye lanp a lwil sa?

wi, sa se yon istwa ki konplike ke mwen va rakonte'w yon lòt fwa pou kounye a ki pwoblèm ou genyen?

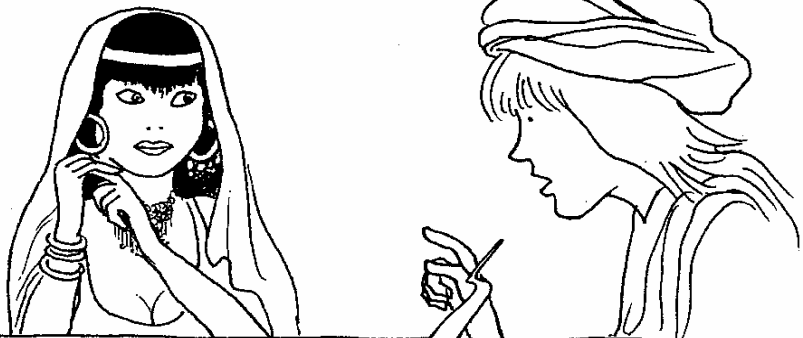

Chatzmani mèt mwen, te di'm konsa l'ap fè koupe tèt mwen demen maten si mwen pa jwenn pou li yon objè ki, lè li fann daprè liy mitan li, ta dwe rebay yon sèl objè. Alò mwen konnen trè byen ke sa enposib. Alò, byen bonè demen l'ap livre'm bay bouro a



hum, trè souvan li pa pridan pou di ke yon bagay posib ou enposib. An nou mande pwofesè Zéphyr avi'l sou sa.

kiyès ki pwofesè Zéphyr a?

Li te rete nan lanp la soti, pwofesè Zéphyr

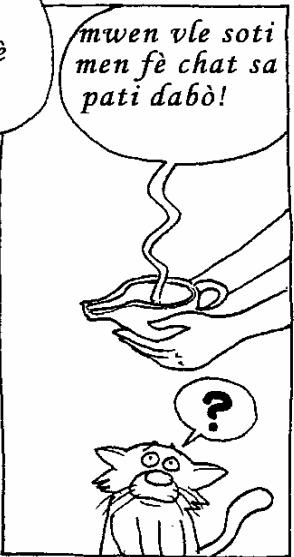

mwen vle soti men fè chat sa pati dabò!



se yon femèl chat, li aje e ou pa bezwen pè anyen

bon...



sa gran vizi a mande sanble ke li enposib. Gade: mwen te fann silend sa daprè pati mitan li, e...

hum, mwen wè sa'l ye. Kòmanse pa rekoud de moso sa yo yon sou lòt



pwofesè Zéphyr toujou gen de bon lide

men...

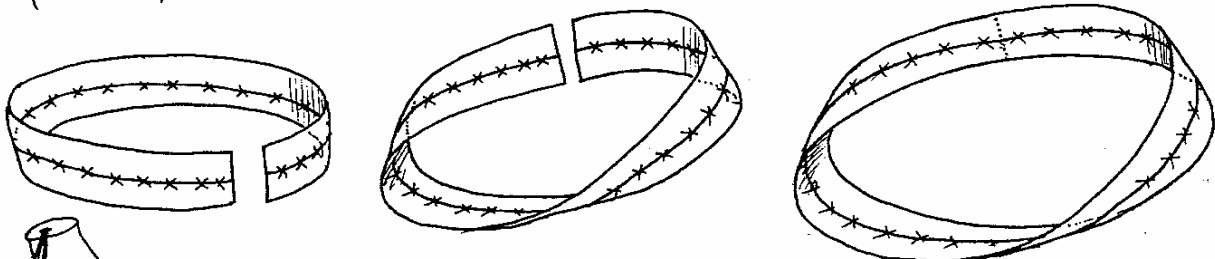

kounye a n'ap koupe band la. N'ap ba li yon demi-tou e n'ap rekole'l sou li menm, jan sa montre sou desen yo



e alò, kisa sa chanje?

men sa chanje tout bagay, gwo benè. Retire kounye a kouti yo, e wa wè



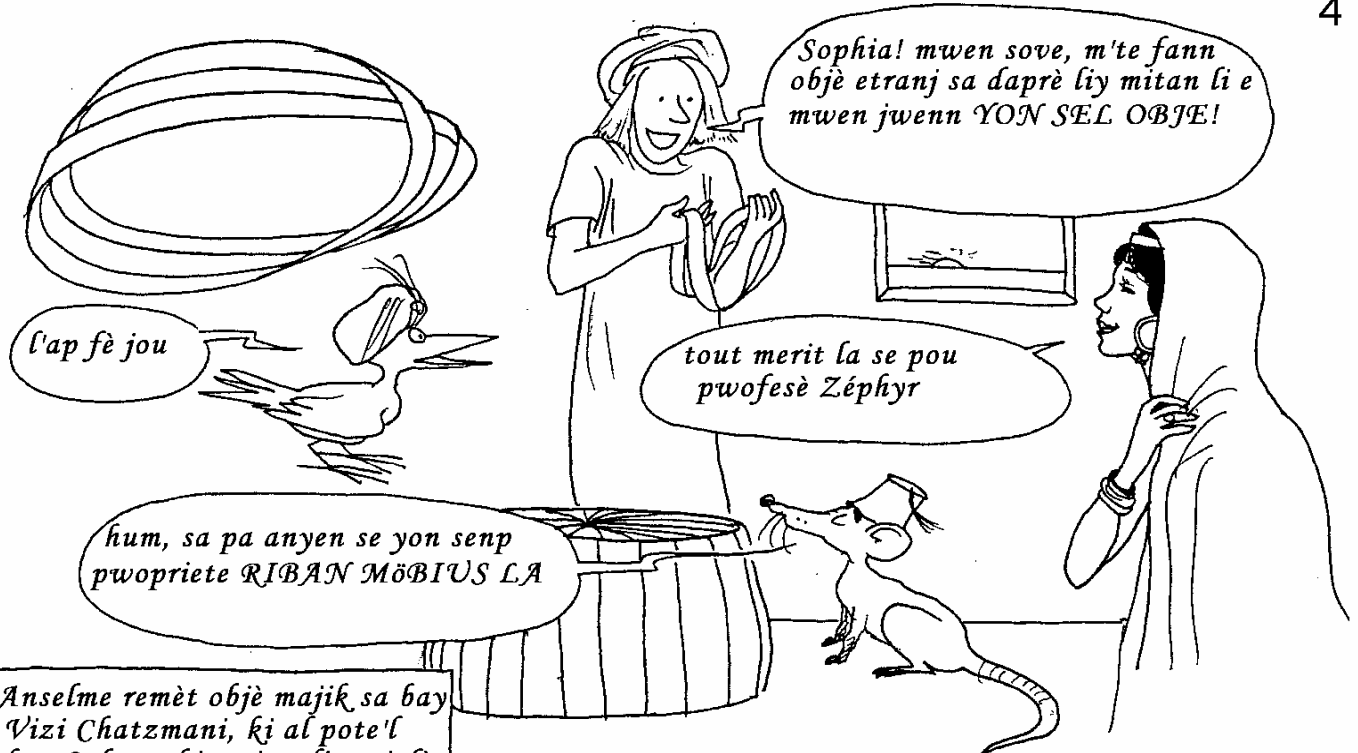

Sophia ak pwofesè Zéphyr retounen nan lanp la, e yo di Lanturlu nan ka li ta bezwen li mèt jis fwote lanp la ankò pou yo tounen vin ede'l



Kalmi retounen pou yon tan anba koupòl bèl vil Ispahan la, ki dore ak lò fen. Men, pandan ke Vizi Chatzmani t'ap kontinye vòlè mèt li avèk konsians e ke Anselme t'ap astike kwiv yo, lannwit vye Sultan an te ante ankò avèk yon bann rèv etranj e difisil.

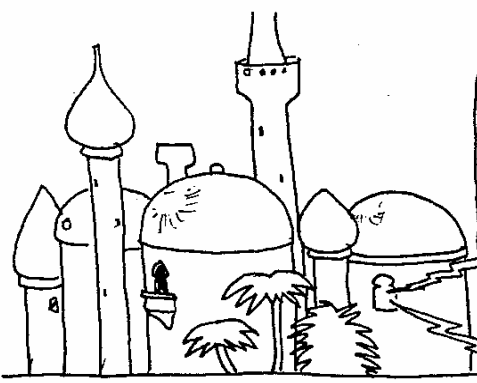

Chatzmani, yès'wa mwen te fè yon bagay etranj : mwen t'ap soufle sou yon objè e objè sa, olye pou'l ta vole byen lwen, okontrè li t'ap vin jwenn mwen. Plis mwen t'ap soufle e se plis li t'ap kole sou mwen. Ale, e rapòte objè sa ban mwen. Li egziste, se sa'k fè mwen te wè'l nan rèv mwen. Pote'l ban mwen avan yon lalin, sinon se lavi'w ki an danje

!?!?

Mil e Yon Nwit Syantifik Yo

2



Chatzmani, gran Vizi a pa kontan ditou

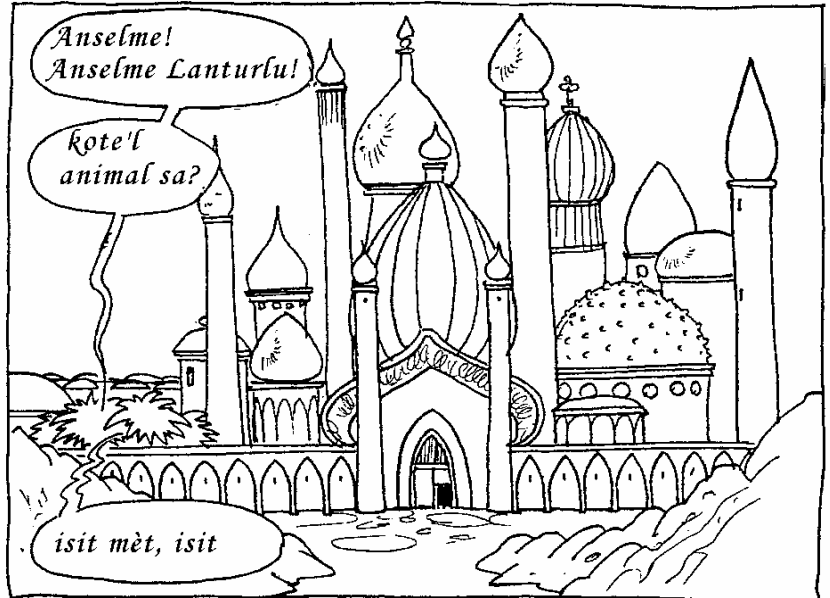

Anselme, isi a de jou w'ap oblije jwenn yon objè tètke lè'w soufle sou li, li vin jwenn ou obye l'ale lwen'w, sinon m'ap fè pann ou!



de jou? Sultan an rakousi delè'l yo! Erezman, gen lanp majik sa

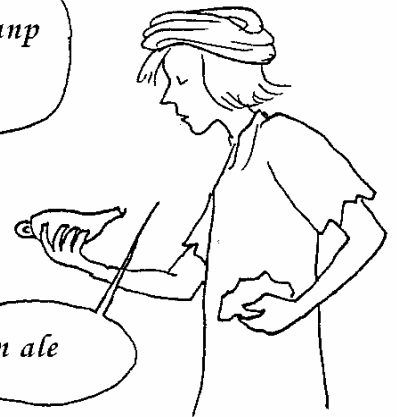
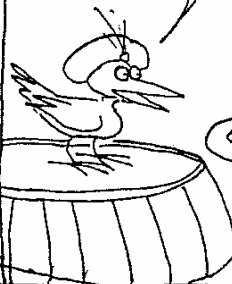

an ale



Anselme, kè'm kontan! Mwen te kòmanse santi'm annwiye

Sophia, nou gen bezwen'w ankò. Sultan an toujou pa gen somèy. Li poze nan rèv, de pwoblèm trè difisil, li mande gran Vizi li a, Chatzmani, pou rezoud yo, e kòm mwen se valè li, tout bagay retonbe sou mwen



sa dwòl. Lè yo soufle sou yon objè, an jeneral li vole

hum, sa depase konpetans mwen. fò nou ta rann vizit a doktè Courandair. Pou sa nou pral fabrike yon tapi volan. Fò nou genyen yon gran tapi kare

nou kòmanse pa woule fèy la sou li menm, kònsa:

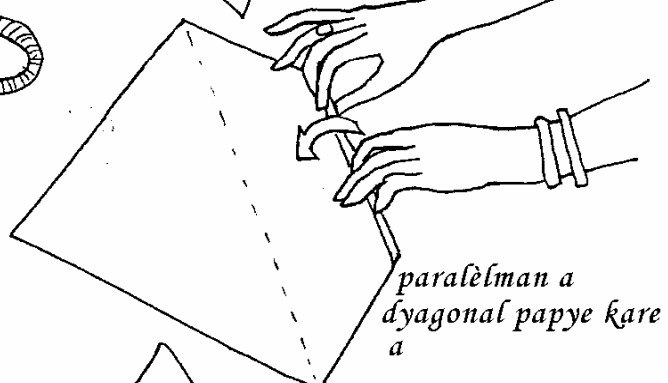

paralèlman a dyagonal papye kare a

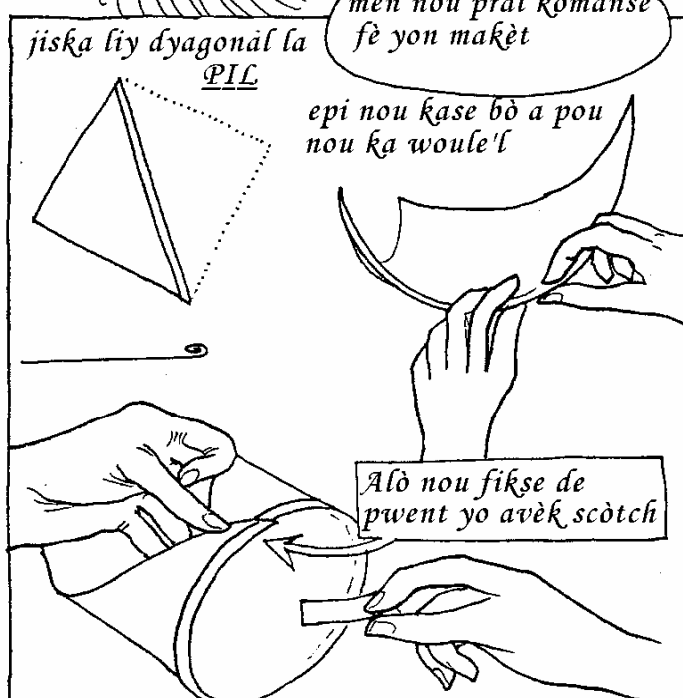

jiska liy dyagonal la PIL

men nou pral kòmanse fè yon makèt

epi nou kase bò a pou nou ka woule'l

Alò nou fikse de pwent yo avèk scotch

e men EPISCOPLAN la

lè'l sou pwofil li

dèyè

devan



lè'l anfas ou

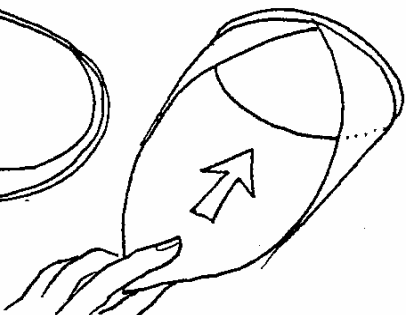

genbe'l pa dèyè e lanse'l dousman, byen plat



se yon chapo?

non, se yon machin volan

si EPISCOPLAN nan fabrike avèk swen l'ap vole kòrèkteman, sou yon long distans. Fò'l pa lanse twò fò, ba li jis sa'l bezwen kòm vitès, kòm si ou t'ap poze'l nan lè a ki pral pote'l

sa alò !?!

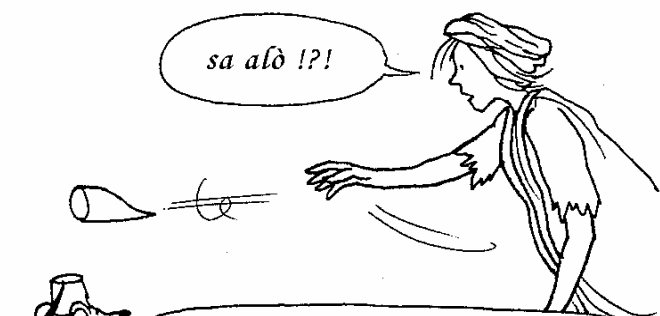

men li. kounya ke ou pran kou a, an'n pase nan reyalizasyon nan vrè grandè avèk yon tapi kare

Lè li pran tapi volan etranj ke pwofesè Zèphyr te fè a, Anselme Laturlu ak Sophia pral rann vizit a doktè Courandair.

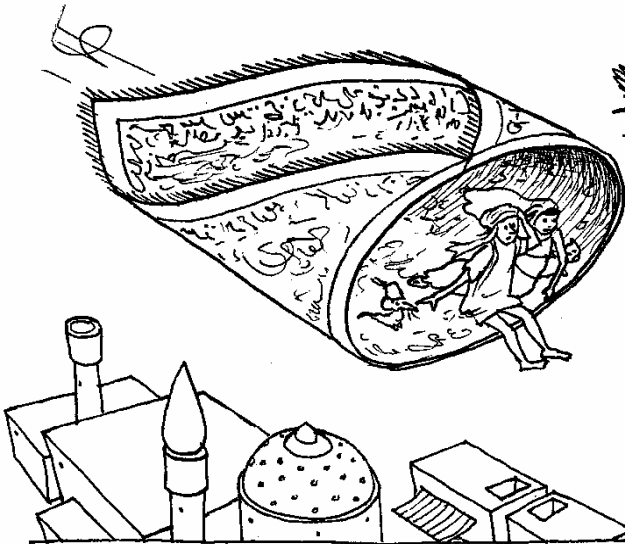

A, nou byen tonbe. Mwen t'ap prepare yon eksperyans



avèk pòm yo?

mwen te akwoche chak pòm sa yo nan yon fil ki fè yon mèt longè, m'aranje'm pou yo ka a senk milimèt distans yon de lòt

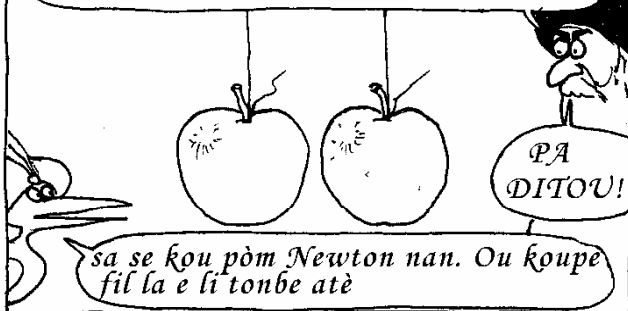

PA
DITOU!

sa se kou pòm Newton nan. Ou koupe fil la e li tonbe atè

mwen SOUFLÈ ant pòm sa yo

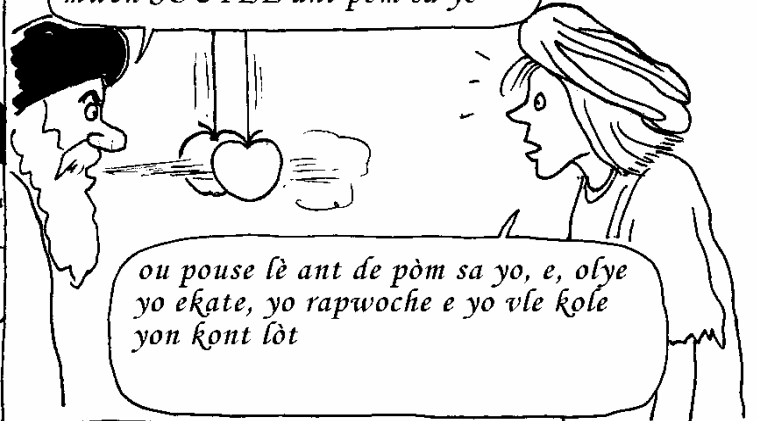

ou pouse lè ant de pòm sa yo, e, ofye yo ekate, yo rapwoche e yo vle kote yon kont lòt

Se nòmal, nan yon gaz, lè vitès la ogmante, presyon an bese. Lè'm soufle ant pòm sa yo, mwen kreye yon **DEPRESYON**



wi, men sou kote jè dè a! Nan aks la, sa pouse objè yo, non?

wi, men, jè dè'w la, ou gen jis pou fè'l vire jan'w vle a



li gen rezon!

A... kòman?

Gade: mwen plake fèy papye sa sou men gòch mwen. Mwen mete bouch mwen nan jwenti ant endèks ak majè mwen, ke'm kite ekate. E mwen soufle pi fò ke'm kapab. Lè a pral soti nan longè fèy la, sou longè sa li pral kreye yon depresyon. E si tout bagay anfòm...



men w'ap soufle sou fèy la!



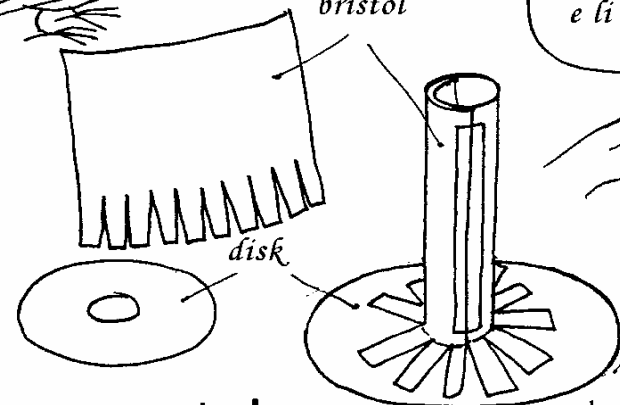

Fò'w itilize lakòl oubyen skòtch pou rakòde you silend sou you disk pèse de you twou won



ASPIRISOUFL LA

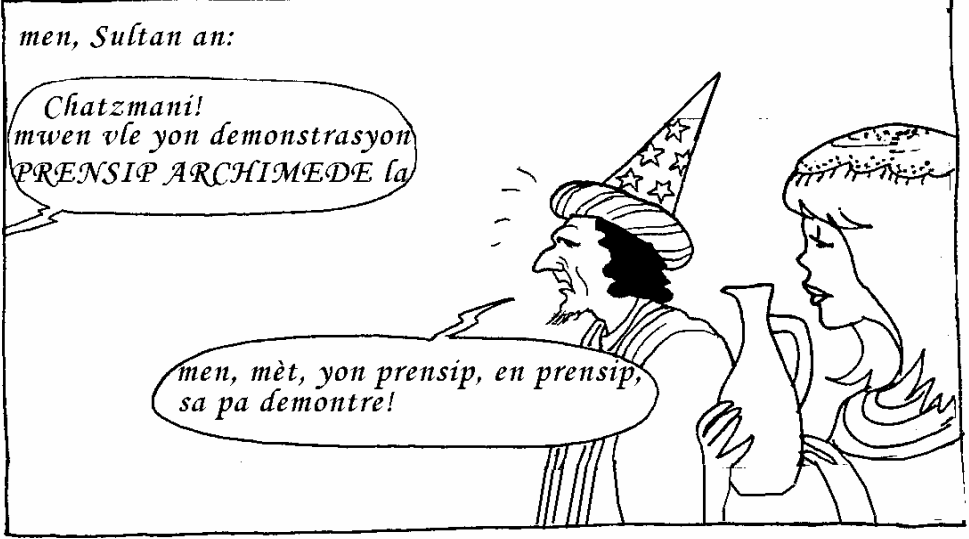

Mil e Yon Nwit Syantifik Yo

3

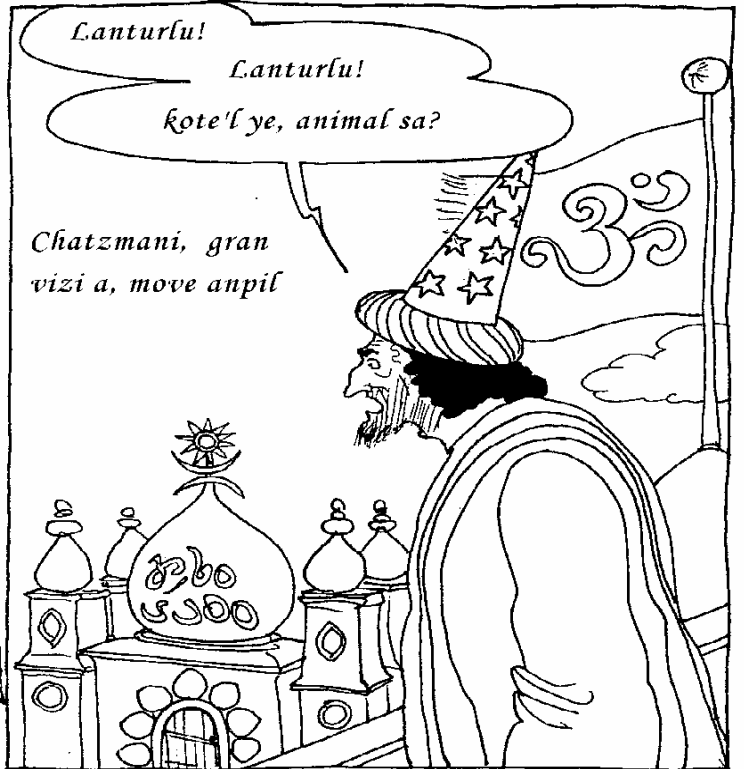

Lanturlu!
Lanturlu!
kote'l ye, animal sa?

Chatzmani, gran vizi a, move anpil



Lanturlu, Sultan an fè yon rèv, yèswa, de yon demonstrasyon PRENSIP ARCHIMEDE la. Li vle ke demonstrasyon sa retwouve

se ou menm ki pou debwouye'w, sinon!

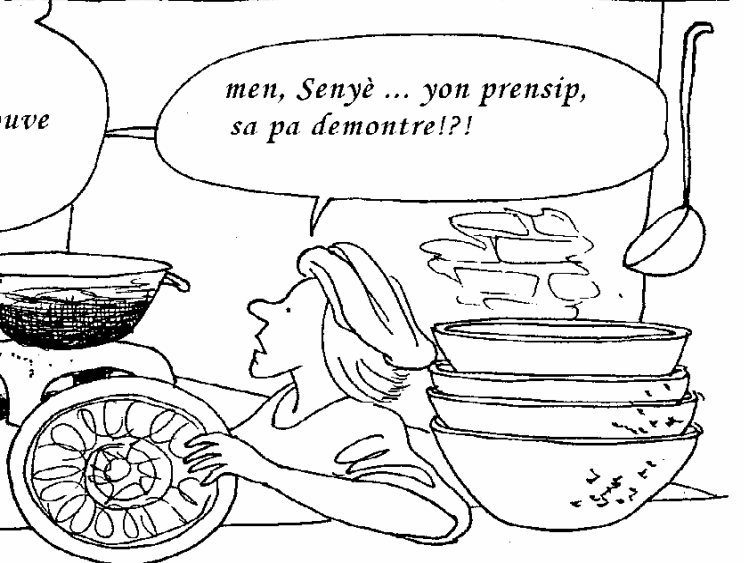

men, Senyè ... yon prensip, sa pa demontre!?!

demontre yon prensip, fichtre...

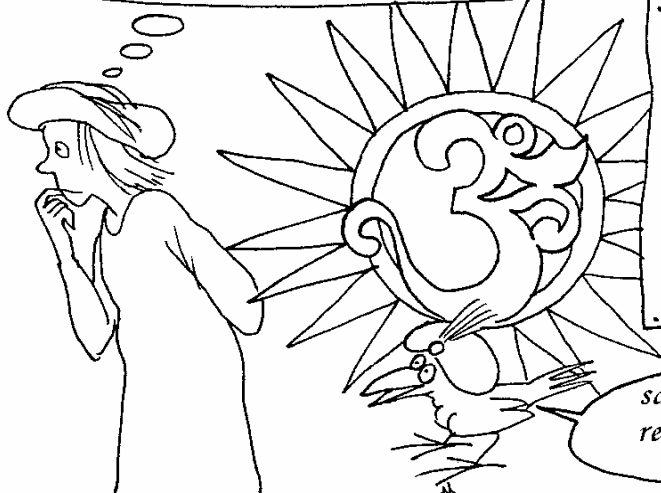

Tout kò ki plonje nan dlo resevwa yon pouse dirije de anba a anwo e egal avèk pwa kantite dlo ki deplase a.

(vè 210 avan Jezi Kri)

sa gen lè konplike. Nou ta dwe rele Sophia

men lanp majik la

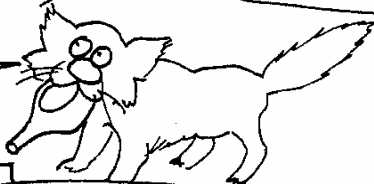

men mwen, Senyè kisa'm ka fè pou ou?



kisa chantye sa ye?

Sophia mande yon materyèl presi



yon balans



yon pòm

dè pwa...





fò gen dlo tou, anpil dlo.
 Se nòm al pou prensip Archimède la

gen yon bòl tou

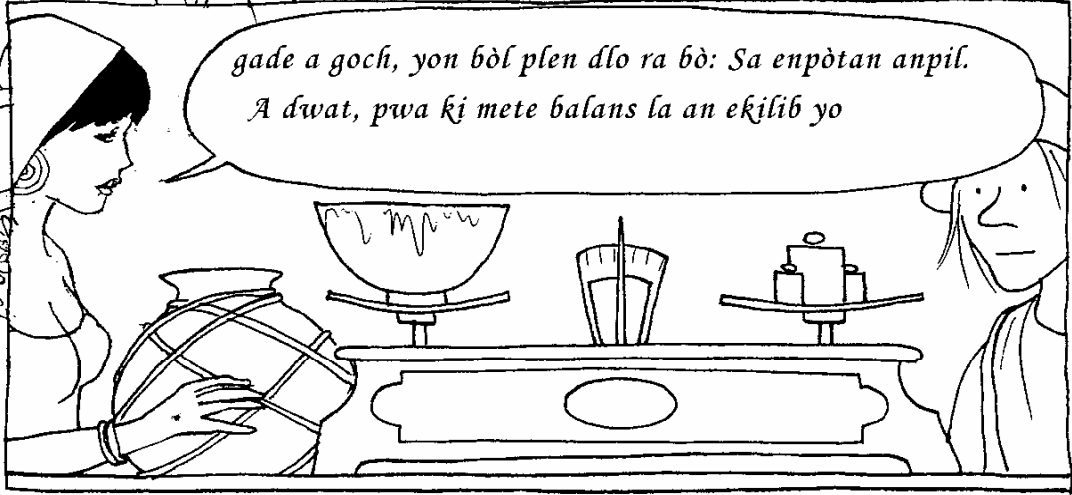

gade a goch, yon bòl plen dlo ra bò: Sa enpòtan anpil.
 A dwat, pwa ki mete balans la an ekilib yo



e kounye a n'ap plonje
 pòm la delikatman

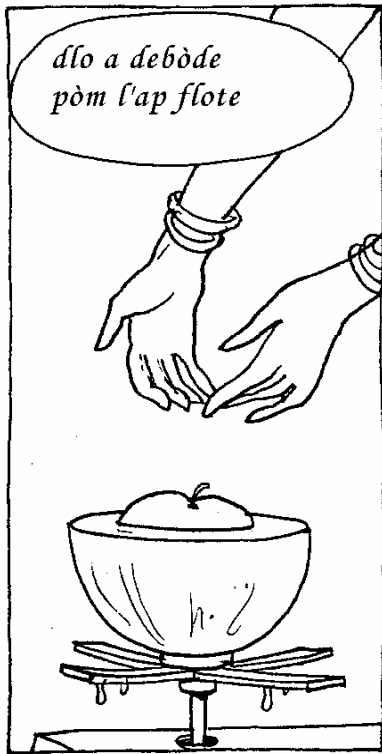

dlo a debòde
 pòm l'ap flote



kisa'k pase la?

anyen!?!

balans la rete an ekilib.
 Eksperyans la rate konplètman

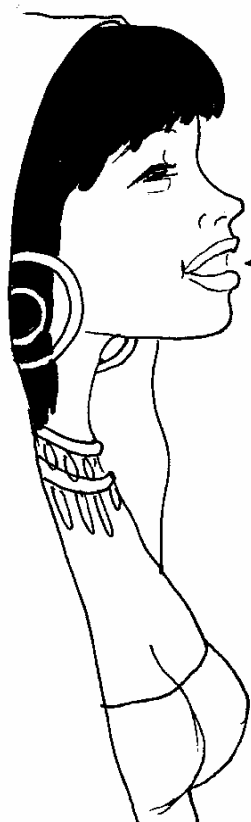

Men non, okontrè. Èksperyans la reyisi: Pòm l'ap flote, donk "pouse Archimède la" ekilibre pwa li. E kisa pouse sa vo? Si'n kwè balans la se pwa kantite dlo ki deplase a, ki koule deyò bòl lè'm te plonje pòm la ladan'l

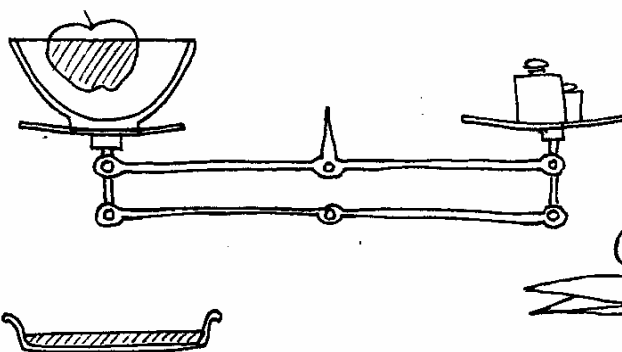

Eureka!



PRENSIP ARCHIMEDE la demontre

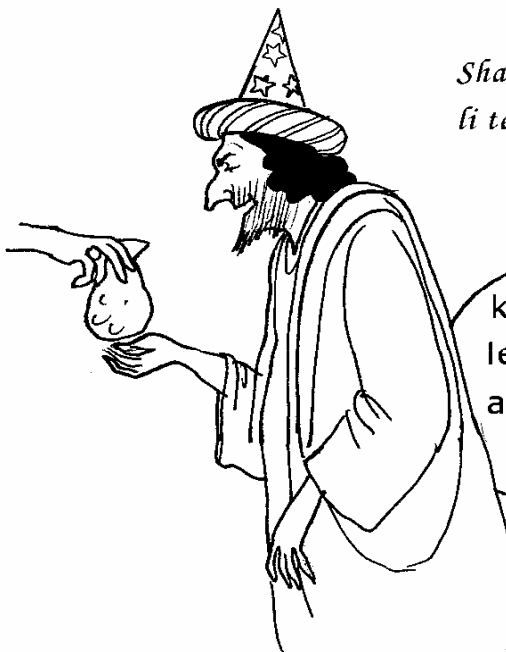

Shatzmani al di Sultan an ke rèv li a te ekfèsi e an retou li te rekonpanse. Lanturlu retounen nan kastwòl li yo.

kout chans, pòm la pi legè ke dlo a. Si se pa't sa adye bèl demonstrasyon'm la

Hmmmm...



Mil e Yon Nwit Syantifik Yo



Sultan an vin fou nèt. Yon majisyen te rann li vizit e li montre'l ke li te ka kanpe kè'l. Kounye a li vle pou mwen akonpli yon tèt mirak, sinon li pwomèt l'ap fè pann mwen!

LANTURLU!

Jan li abitye fè gran Vizi Schatzmani fè tonbe tout sa sou tèt Lanturlu

e sonje. Ou gen jiska demen pou'w jwenn sa, sinon!..

Ta sanble majisyen an te mete trant lane pou li reyisi mirak sa

pandan tout tan sa li ta nourri tèt li sèlman avèk nwa

fò'w gen trant lane w'ap medite pou'w rive kanpe kè'w

sa pa lasyans ankò, la, sa se maji. M'ap mande'm si Sophia ap ka fè yon bagay

Ann eseye kanmenm. Men lanp la



A, cheri'm yo, m t'ap tandé nou, nan fon lanp la e m'ap avwe, nou te byen fè'm ri. Majisyen nou an se yon jwaye fumist. Kòman li fè pou konstate ke li "kanpe kè'l"?



e byen, li mande pou nou pran pouf li..

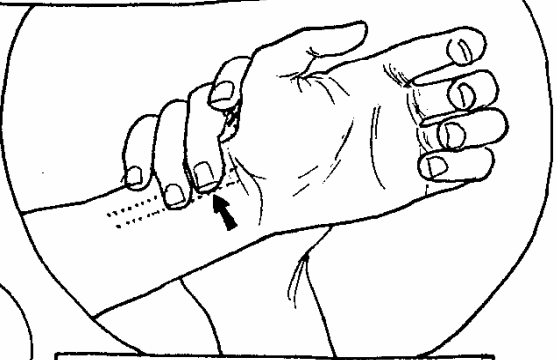

e kisa ki genyen ant "pouf" avèk kè a?

kòman pou pran pouf la



an prensip gen vesò sangan yo, yon artèr ki mennen san an

ou vle di se kònsa li kanpe pouf li, li anpeche san an ale de kè'l vè ponyèt li



men avèk kisa?

avèk sa!



men se yon senp nwa!?!



èske nwa sa gen pwopriété famasetik?

pa gen anyen pou wè ak sa.
Nwa sa, ou plase'l la, anba esèl
la, kote artèr la pase ki alimante
bra'w avèk san fre

Li pa remake e si mwen
pa sere bra'm kont kò'm
w'ap santi poul mwen
nòmalman

men si mwen sere san'w pa wè nwa a anba
esèl mwen, artè a vin konprime. San an pa
pase ankò e ou pa santi poul mwen

se sa, lafwa'm se vre!

lè'm panse ke majisyen kreten sa, lè li twonpe Sultan nou an, te resevwa yon
bous plen lò, lè li fè'l kwè "ke li gen pouvwa"



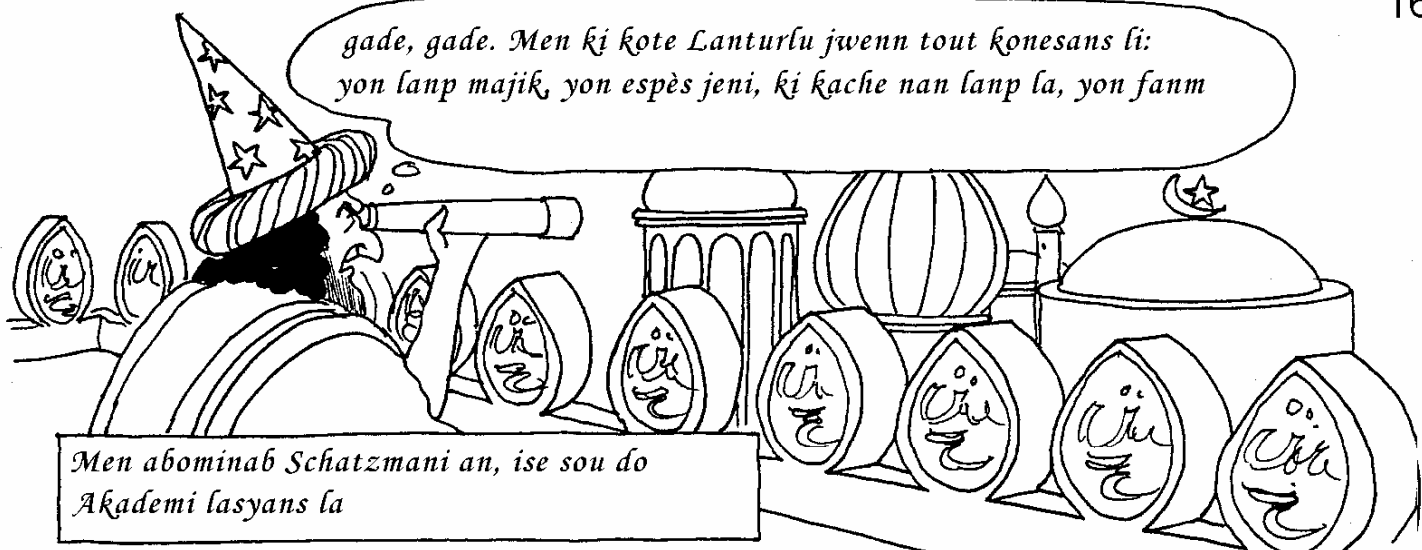

gade, gade. Men ki kote Lanturlu jwenn tout konesans li: yon lanp majik, yon espès jeni, ki kache nan lanp la, yon fanm

Men abominab Schatzmani an, ise sou do Akademi lasyans la



Hmm... trè astisyè



rete'm jis pou m'al wè Sultan an. Men mwen pa bezwen eksplike'l trik nwa anba esèl la



byen, valè. retounen kounya nan travay ou e pran pyès sa

oh, mèsi...



Schatzmani ban mwen yon pyès. petèt ke li pa si move, aprè tou...

Pffff... se yon senp sou an kwiv

Anselme! Lanp majik la! Li disparèt!!!

Mil e Yon Nwit Syantifik Yo



alò men lanp majik sa kote Lanturlu jwenn tout konesans li. Ou dwe jis fwote'l, jeni an soti nan lanp la e li rezoud nenpòt pwoblèm.

mwen pa bezwen'w ankò kounye a. Lè dlo sa va ranpli sitèn nan, ou pap yon pwoblèm pou mwen ankò!

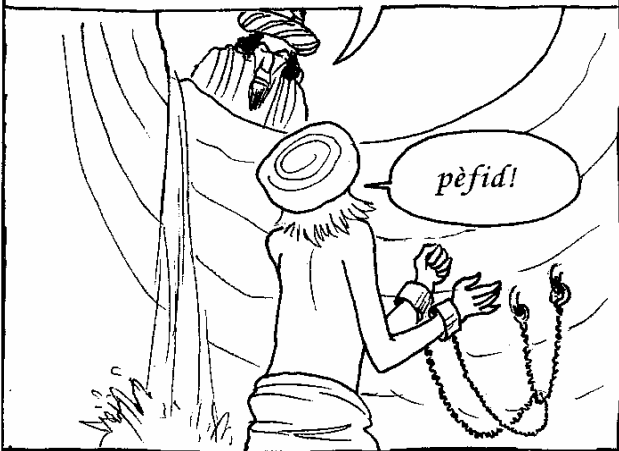

Senyè, mete'm a l'eprev. Mwen genyen ase konesans e mwen kwè mwen ka rezoud nenpòt nan enigm ou yo



Byen, mwen va rele'w lè m'a wè yon nouvel enigm parèt pwent tèt li nan yon nan rèv mwen yo

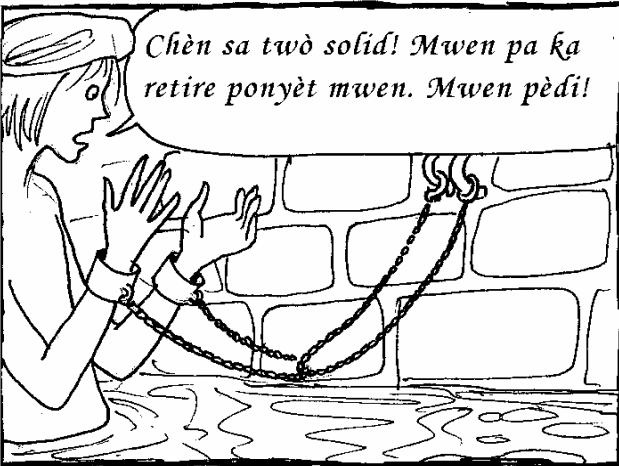

Chèn sa twò solid! Mwen pa ka retire ponyèt mwen. Mwen pèdi!

Anselme.... mwen pa ka ede'w dirèkteman paske mwen fèmen nan lanp majik la, men konnen ke pwoblèm sa gen yon solisyon...



Yon solisyon!?! men, Sophia!
li EVIDAN ke pwoblèm sa pa gen
ankenn solisyon e ke mwen kondane
pou'm mouri



pa enève'w. Ou ka detache'w...
paske ou pa vrèman atache!

Hein!?!

reflechi: Ou ka retire ponyèt ou nan menòt yo,
men, pa kont, chèn yo ka pase ant menòt yo
avèk po ponyèt ou

Lè l'ap reflechi, Anselme fini pa jwenn
solisyon an

Nou defòme menòt yo avèk pwen
Lanturlu pou ke

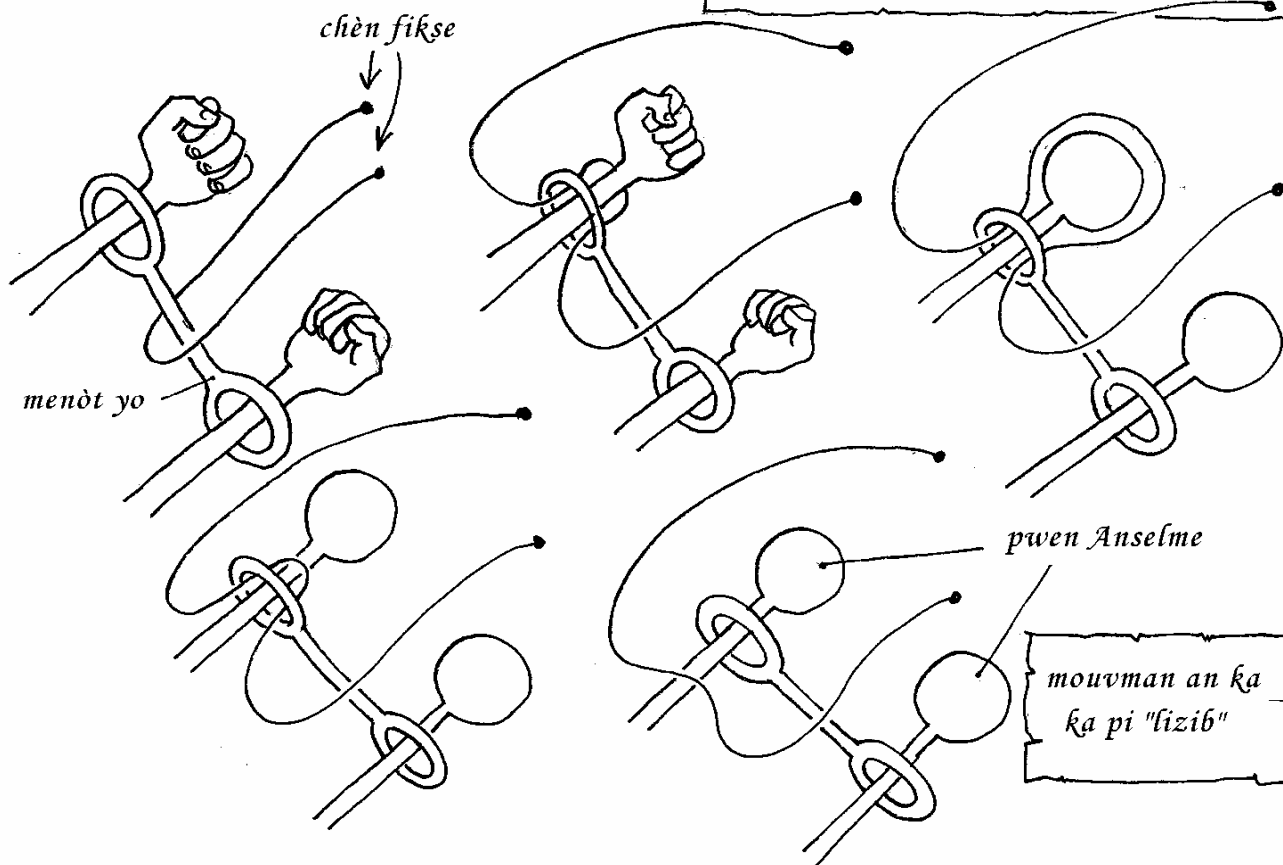

Pou ke lektè a ka refè fasilman tou a li menm, avèk fisèl, nou fè braslè Anselme yo pase pou de senp braslè an kòd.

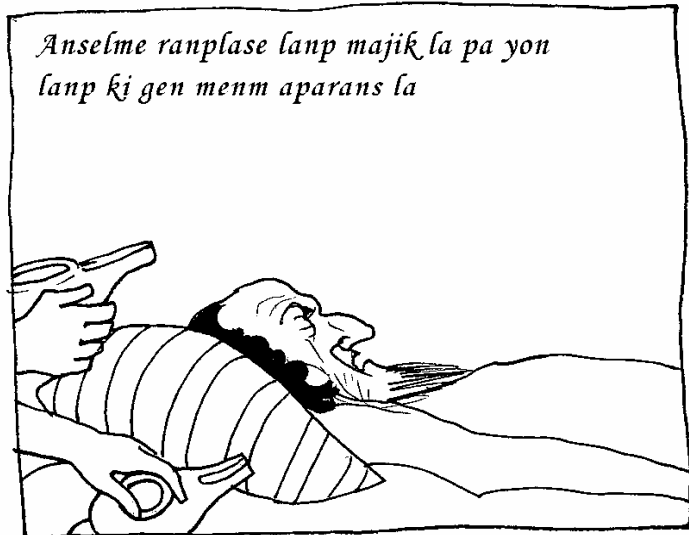
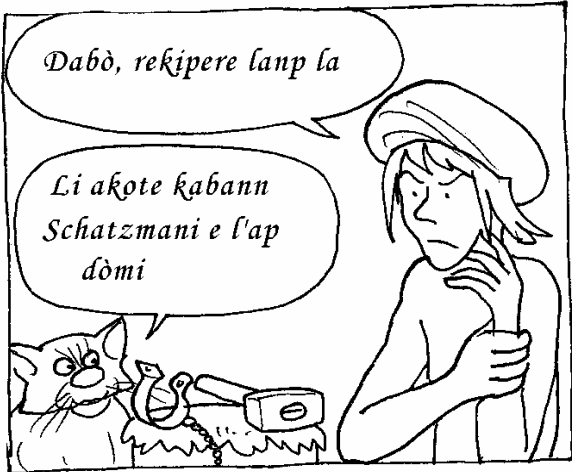
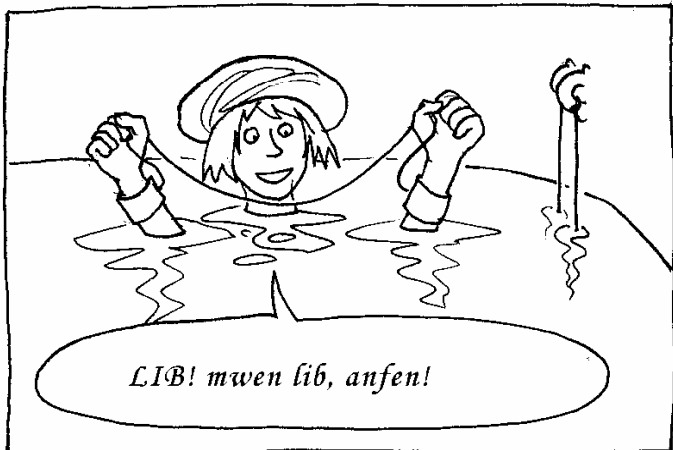
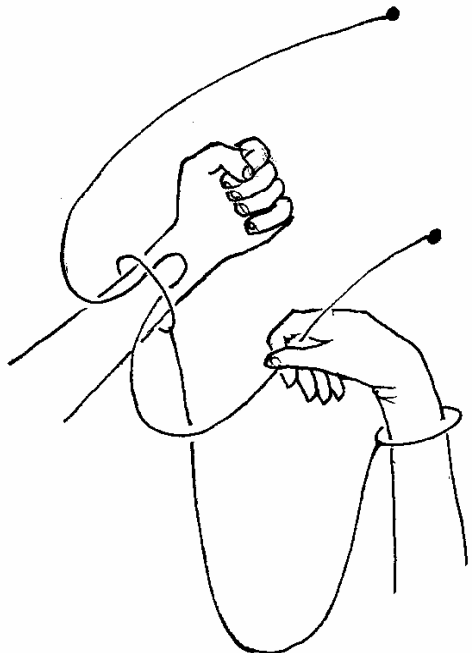
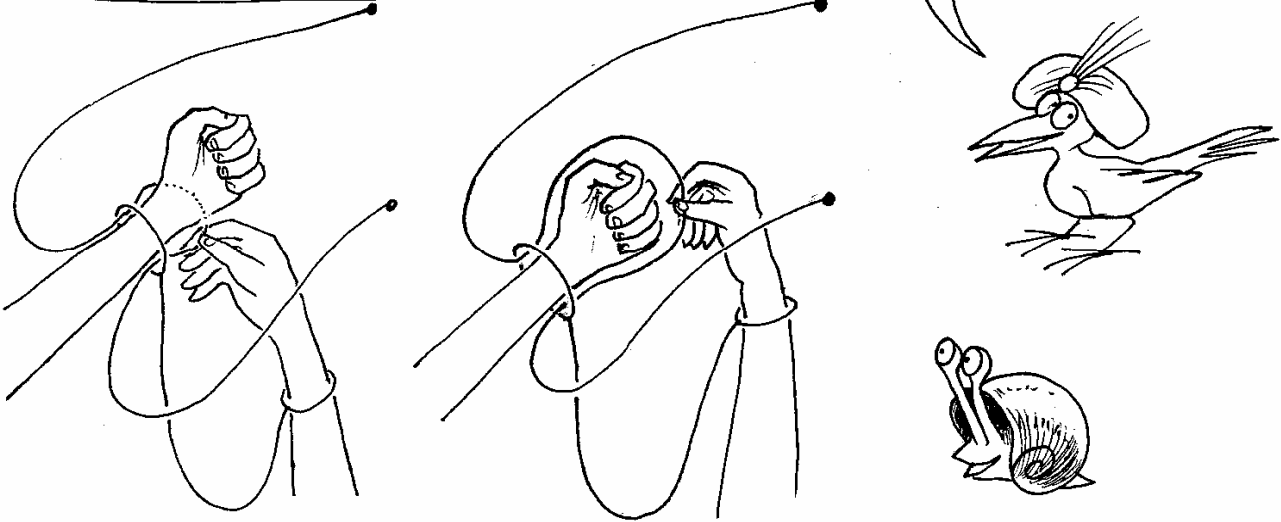

Gade yon bèl matine ann al wè
si Sultan an fè yon sonj ki genyen
yon nouvell enigm syantifik

Sultan an te reve ke li te atache konsa.
Nan rèv la li te reyisi pran kse sa e li libere
tèt li

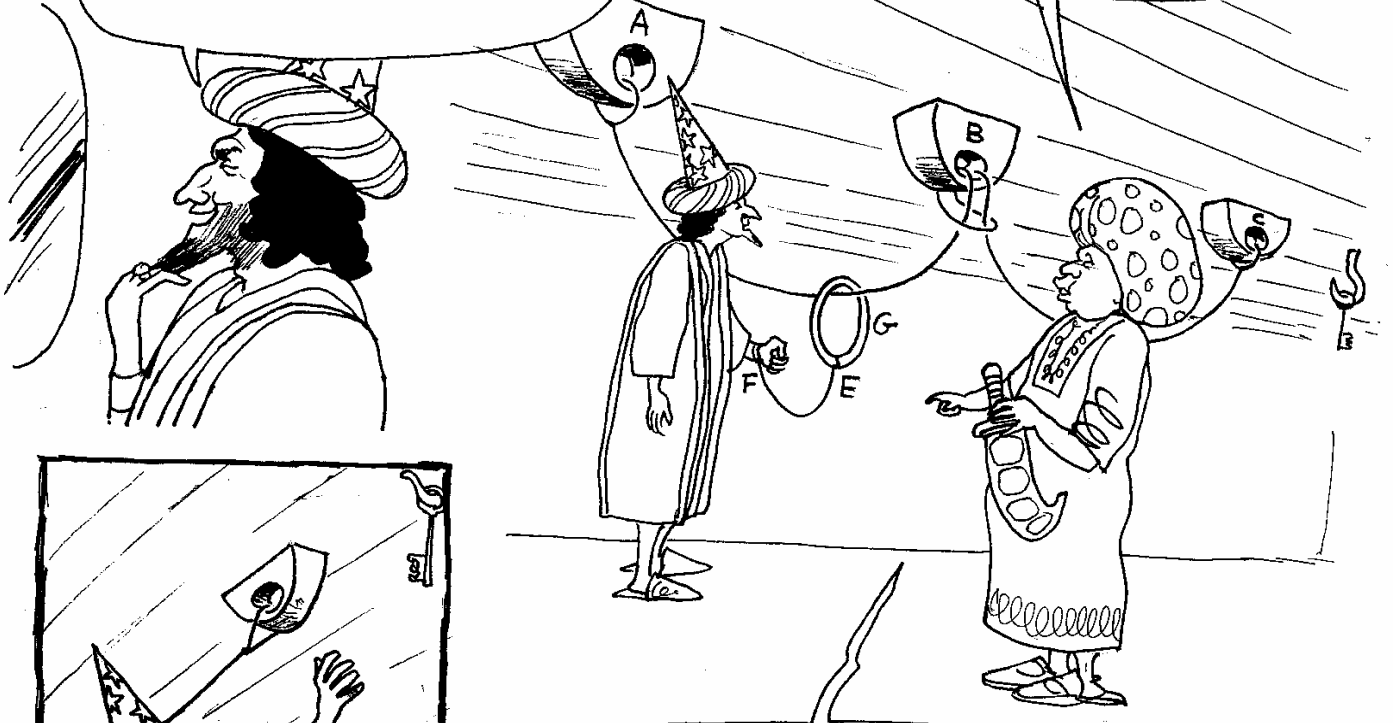

A, yon presizyon: Nou pa ka defèt lyen A, C, F, E e ano G,
rijid la, pa ka nan ankenn jan, pase nan twou B a.

evitamman, enposib pou
jwenn kse a lè'w tire
senpman sou lyen an

Bon, tou sa rete'm se fwote
lanp la



hein? Anyen! e poutan m'ap
fwote depi inè'd tan



e poutan pwoblèm sa gen yon solisyon
(wè pwochen nimewo a).



Mil e Yon Nwit Syantifik Yo

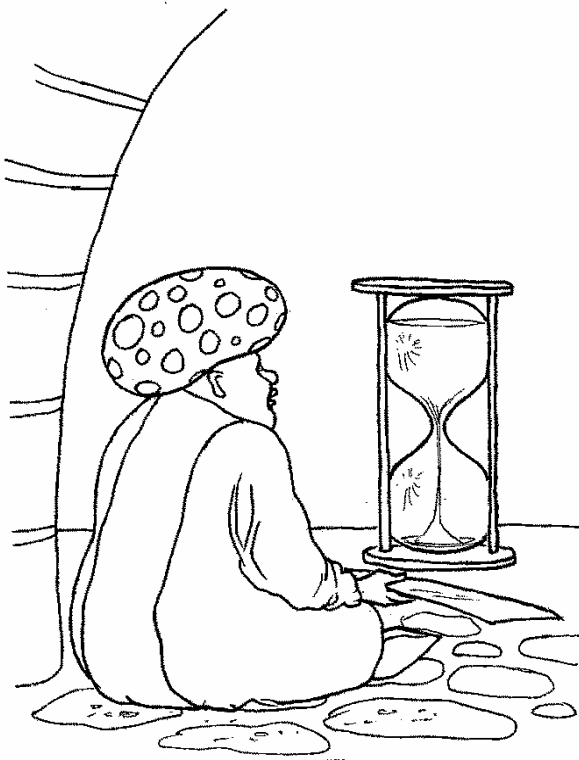

Schatzmani pyeje tèt li pou kont li. Kòm li te kwè ke li te gen lanp majik la, li te di Sultan an ke li te ka rezoud nenpòt enigm. Men kòm li pa ge bon lanp la,

Hmm...

An nou konsilte pwofesè Zéphyr



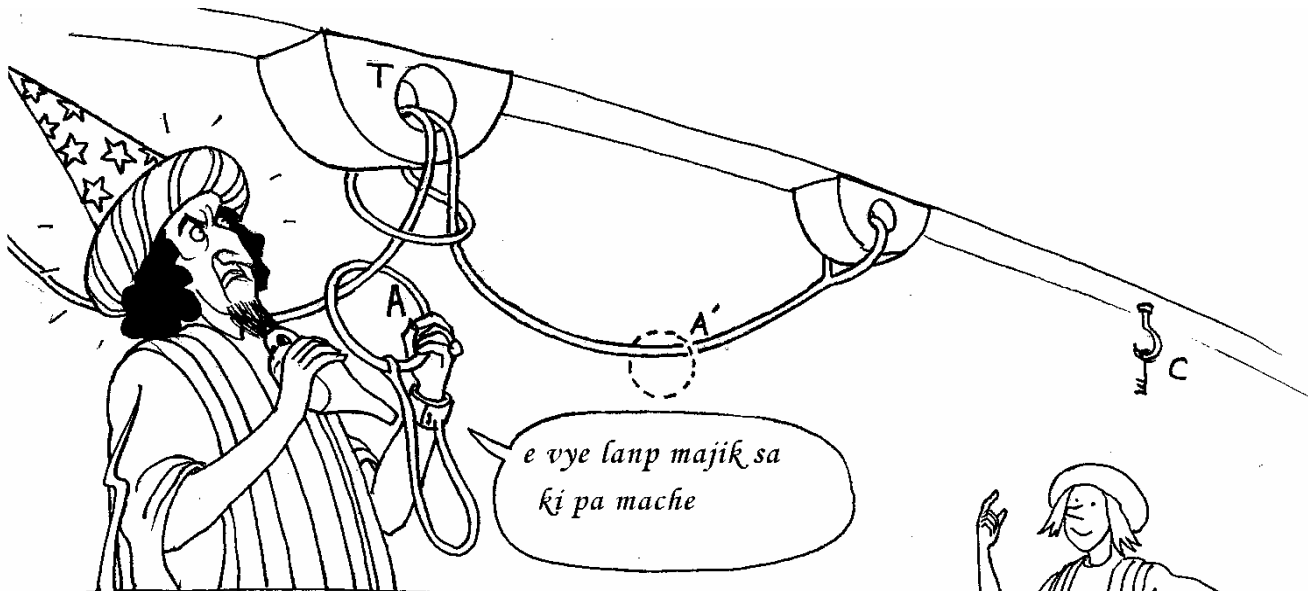

e vye lanp majik sa
ki pa mache

Ano A, ke mwen atache avè'l pa menòt sa,
pa ka pase nan twou T a. Mwen pap janm
ka mete ano a nan A, pou ke mwen ka jwenn
kle a e libere tèt mwen



mèt, ou pa itize'l
kòrèkteman



fò'w mete lanp la nan zòrèy
ou, kònsa e ou resevwa
eksplikasyon yo

vit, ban mwen!



men!... mwen pa
tande anyen!?!

ou gen le kòmanse
tande di



mwen pral eksplike'w
kòman pou'w soti nan
move pas sa

wi... wi...
se sa...

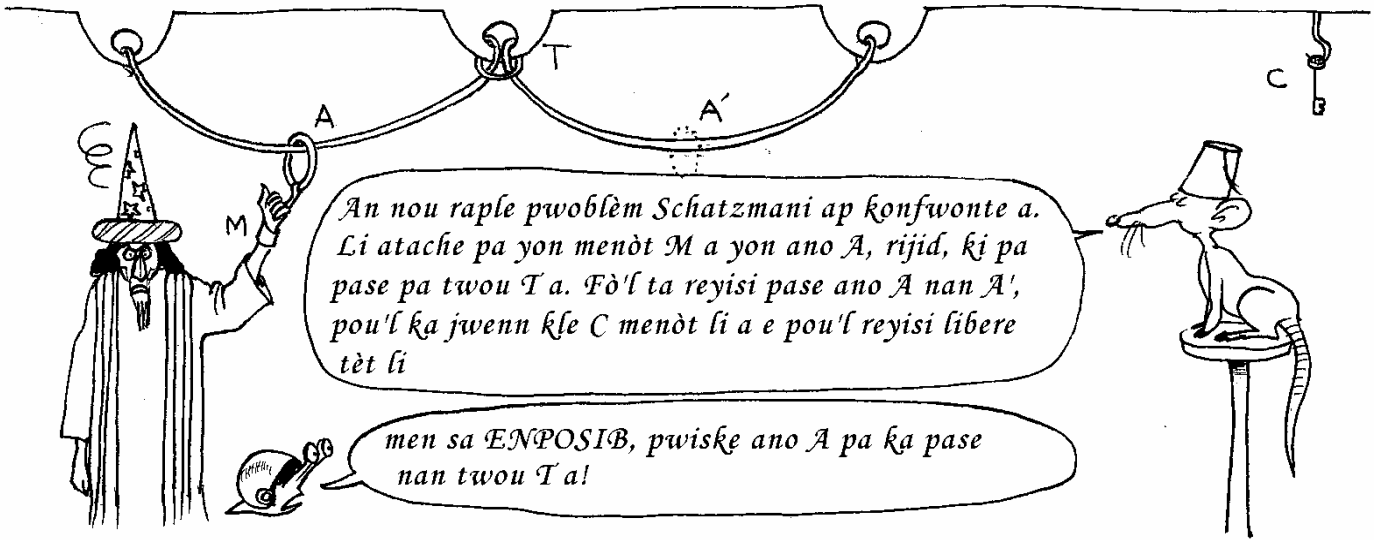

An nou raple pwoblèm Schatzmani ap konfwonte a.
Li atache pa yon menòt M a yon ano A, rijid, ki pa
pase pa twou T a. Fò'l ta reyisi pase ano A nan A',
pou'l ka jwenn kle C menòt li a e pou'l reyisi libere
tèt li

men sa ENPOSIB, pwiske ano A pa ka pase
nan twou T a!

Fè sa avèk yon moso katon pwès pwès, fisèl ak yon gwo ano rido

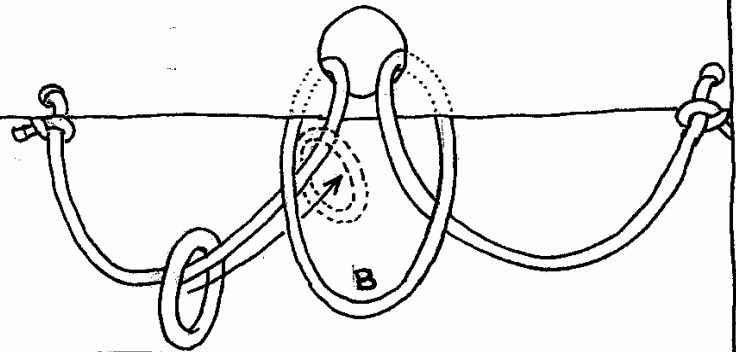

kite bren B a byen pran pou fè ano a pase jan li endike a

N'ap rele sa "pozisyon atant ano a". Kounye a fò'w tire fò sou bren yo (flèch) pou fè ans A a pase nan twou a

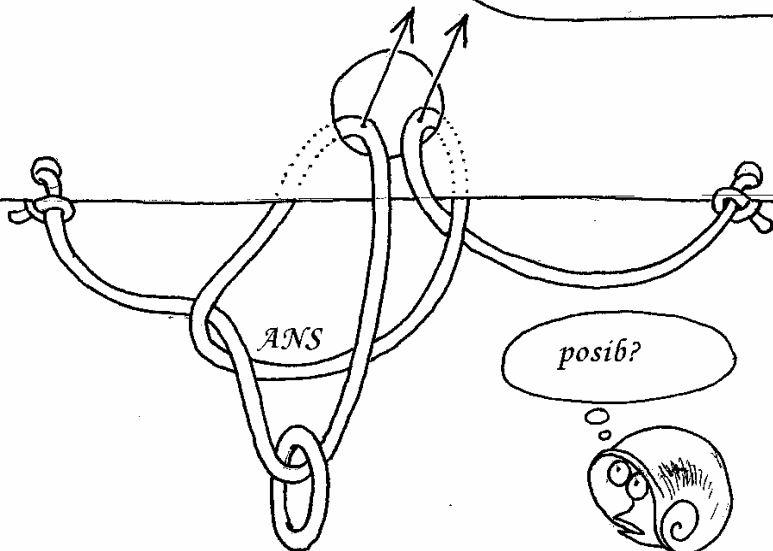

mi!

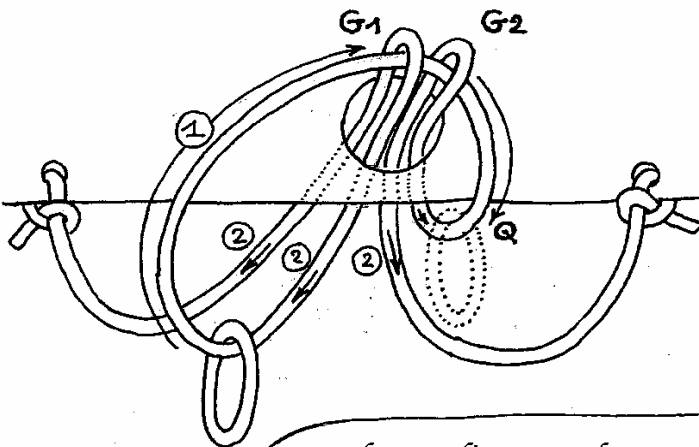

yon fwa sa fèt, ano a ka pase pa de gans G1 e G2 e jwenn pozisyon Q a. Rete jis pou tire sou bren ki gen flèch yo pou raple G1 e G2 lòt bò twou a

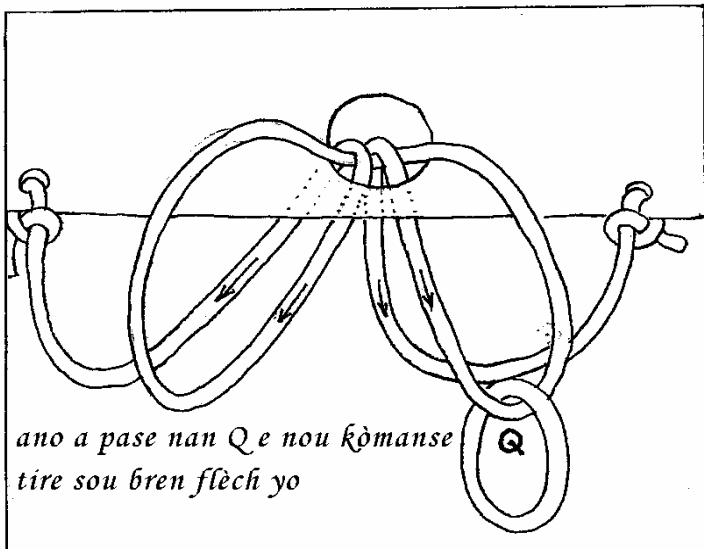

ano a pase nan Q e nou komanse
tire sou bren flech yo

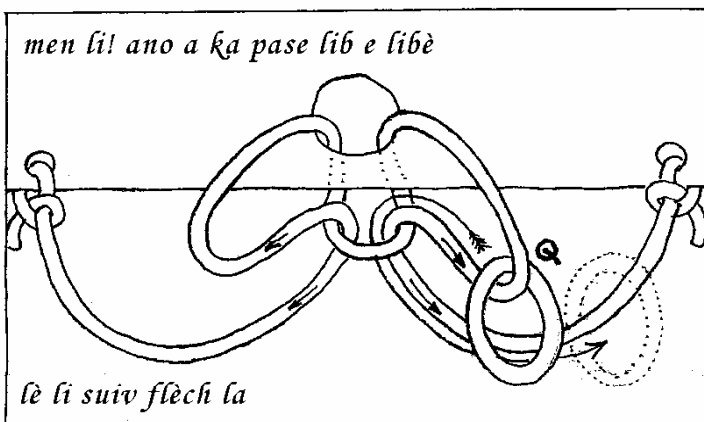

men li! ano a ka pase lib e libe

le li suiv flech la



le a rive...



men li, met men
lanp ou a



SCHMGRR

ou pa konn pi bon an? Schtzmani al
we yon maj pou pran swen pwoblèm
pa tande li a

Sanble ke Sultan an reve de yon bwat ki ka
deplase pou kont li, san fil, ni anyen! Sanble
menm ke li ka monte kot yo!

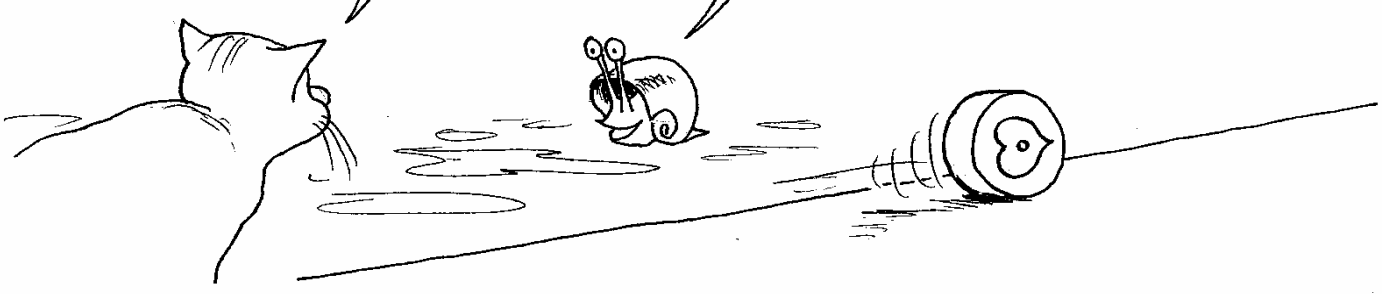

Mil e Yon Nwit Syantifik Yo





gade Anselme! Li pase tan'l nan fè Sophia soti nan lanp li, pou yon wi ou pou yon non. Li dwe gen anpil kesyon syantifik pou poze'l

m'ta di pito ke li amoure



pandan ke Schatzmani, ke Lanturlu te bay yon lanp ki pa majik ditou, pa konprann poukisa lanp sa refize pale avè'l

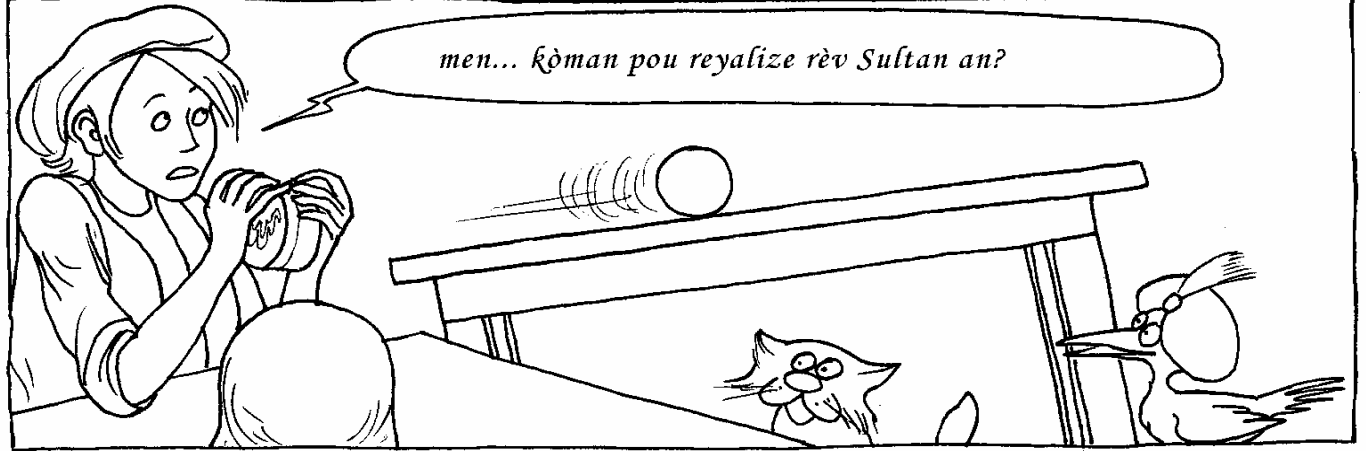

men... koman pou reyalize rèv Sultan an?



men kfe mistè a, sous enèji a

sa! men se yon senp elastik!?!



fò dabò'w fè yon twou nan mitan chak fas bwat la (*)

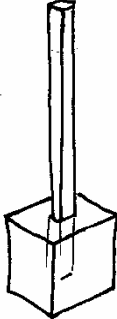

fikse answit nan bout yon alimèt yon ti objè lou, k'j sèvi de kont-pwa (plon t'ap pi bon)



fò'w kwense alimèt la nan bag elastik la, konsa. li fikse nan mitan de fas bwat la, nan mannyè pou li tann lejèman (*) (*)

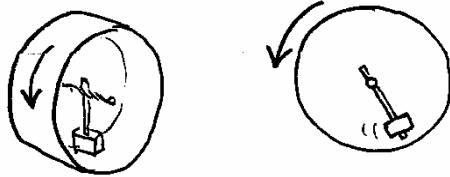

epi nou vire bwat la pou "remonte" elastik la



si ou poze bwat la dousman, li tonbe woule

fòmidad!



li ka menm remonte pant k'j modere, jis lè li kanpe

bagay sa dyabolik!

(*) yon bwat metalik, pilil ou byen bonbon myèl

(***) fò'w gen yon elastik mens e soupl!

non, Tirésias, li mekanik

bon, ann al eksplike tou sa a Schatzmani, ki dwe ap ba tèt li pwoblèm akote yon lanp ki pa ka pale

A, l'ap dòmi! li dwe t'ap reflechi. sa fatige'l toujou. mwen pral remonte bwat la e m'ap kwense'l avèk lanp la

pa dlo nan je Allah yo, bwat la soti nan lanp majik la!

l'ap deplase pou kont li. CHAITAN(*) dwe anba'l!

an al fè yon poze. Avan'l rive konprann kòman sa mache, nou la pou yon bon moman

(*) djab lakay oryantal yo

Mil e Yon Nwit Syantifik Yo

8

mwen genyen senk pyès bronz
avèk tout lide sa yo ke mwen
bay Schatzmani

ki sa mwen pral
kapab fè avè'l?

tande, senyè. Ou gen yon pyès?
Si ou vle, ou kapab genyen yon lòt

gade, chanjè a
ki sa l'ap rakonte la?

ou dwe jis jwe avè'm. Ou jèn,
ou rapid. Ou pral genyen kanmenm!

achte yon nouvo Turban?

kek Loukoums?

li trè senp, tandè: Ou pran yon nan pyès ou
yo e ou mete'l nan men'w byen ouvè, konsa

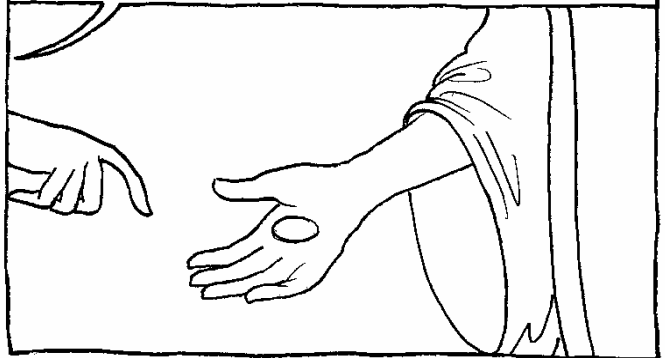

kounye a, mwen mete menm jis anba men'w, kousa. Ou menm ou dwe kenbe men an byen ouvè. si mwen reyisi pran pyès ou a avan ke'w refèmen men an, l'ap pou mwen, sinon m'ap ba'w yon lòt

men'l gen anpil wout pou fè pou pran pyès la, alò ke mwen, m'dwe jis pliye dwèt mwen. se yon jwèt idyo e mwen ta dwe genyen fasilman



dakò



ou prè, m'ap konsantre'm

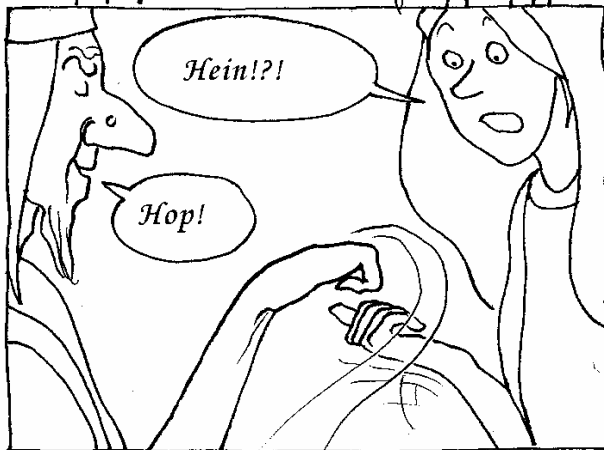

Hein!?!

Hop!



e men li! Ou vle rejwe?

wi

li pran twa pyès mwen. Fò'm eksèsi sa. Vit, lanp la



AH! AH!



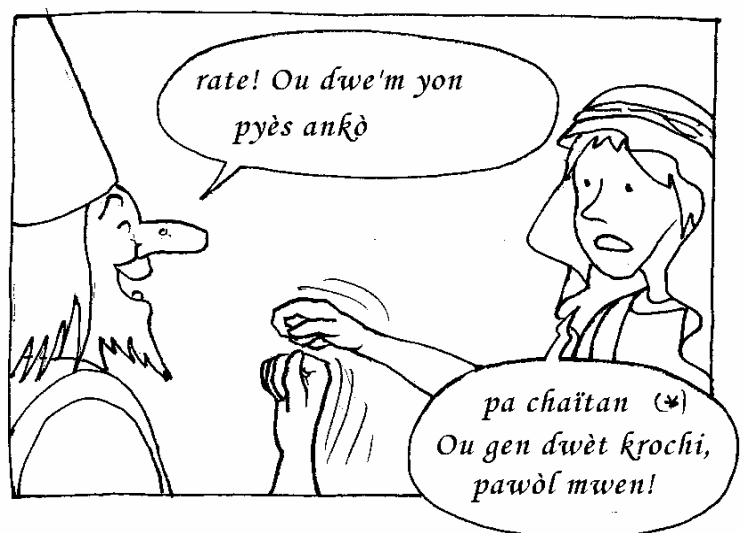

Sophia, mwen pa konprann ankò. Eske li ta vrèman pi rapid ke mwen?



Non, men li gen yon jan trè rapid ke li pran pyès la. Mwen te ka obsève'l

(*) Djab la

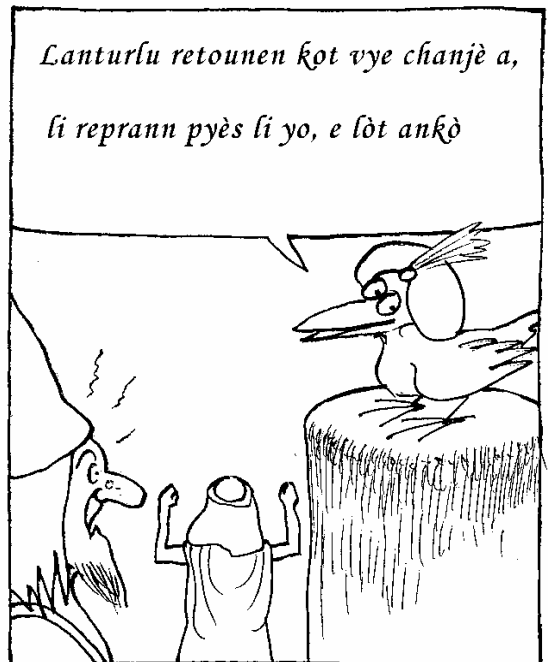
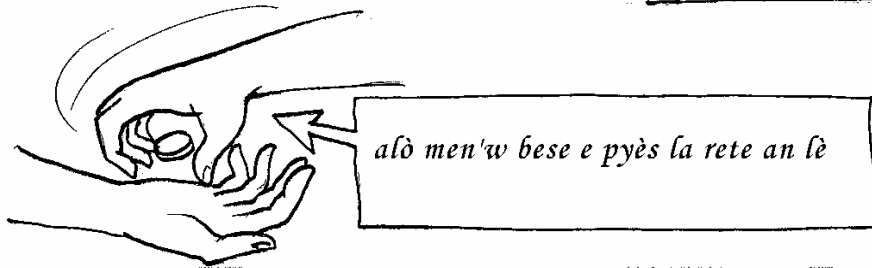



fò gen yon aspirin pou Sultan an, vit!

kisa'k pase?

li fè ankò yon nan rèv sa yo!

al chache Schatzmani pou mwen!

e alò, senyè?

Tande, lannwit sa, yon nan 7 jeni k'ap gade mond la te vin jwenn mwen. Li lonje yon biy ban mwen, yon biy majik, e li di'm: gade'm dwat nan je e touche'l'



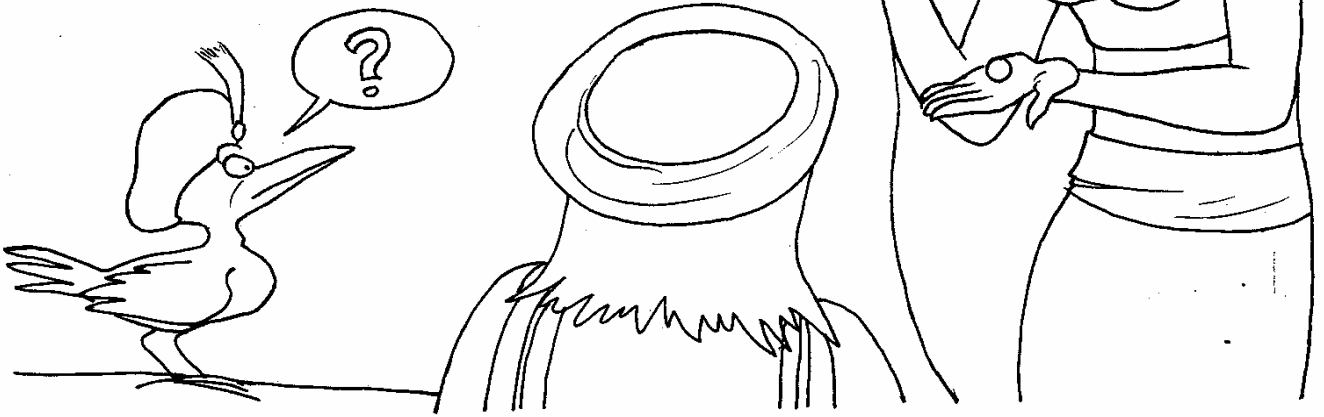

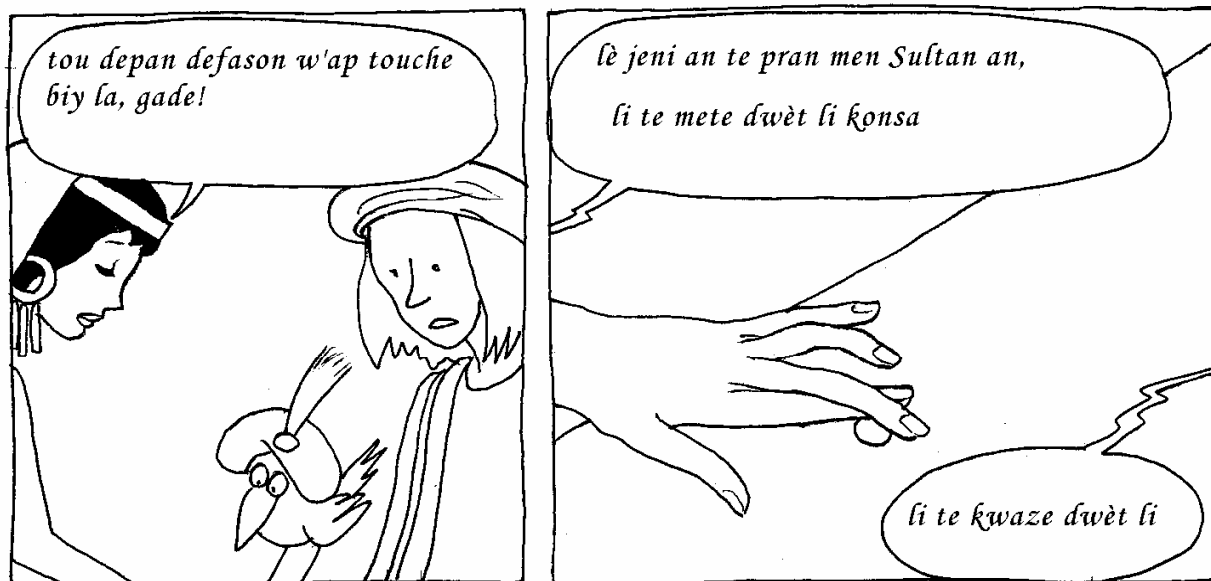



li sot genyen yon bous plen lò, nan men Sultan an.
An efè, li fè yon bagay ke ankenn lòt moun nan
wayòm nan pa't ka fè aprè li. Menm sa'k pi fò e
sa'k pi abil yo

Schatzmani, konsilte, te di ke li
dwe gen lè te fè yon pak avèk Chaïtan*
li menm, pou'l ka fè yon tèl mirak,
Li di ke li gen "men djab la"

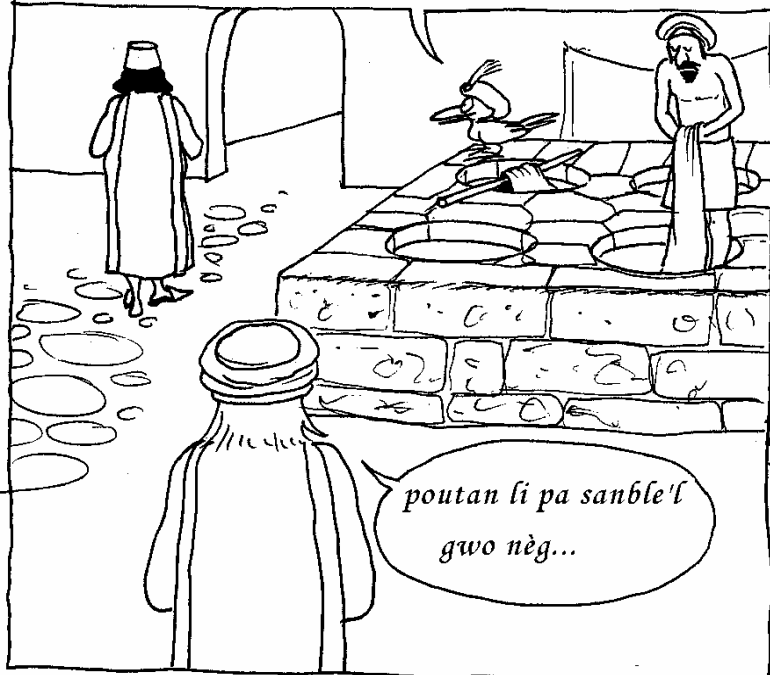

(*) Djab oryantal yo

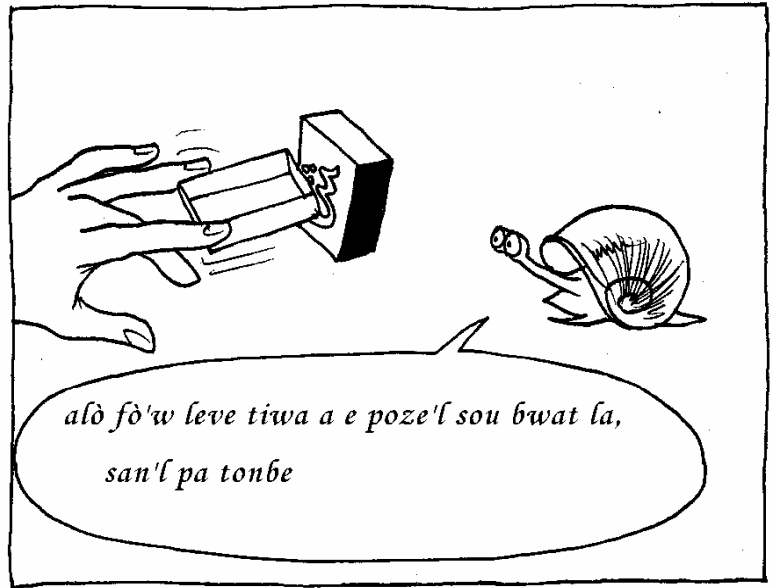
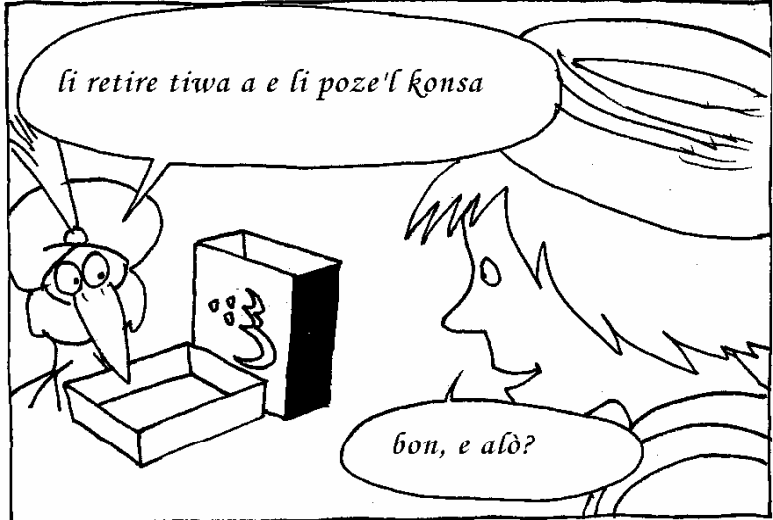

(*) yon ti bwat alimèt



men ki kote nèg avèk aparans frajil sa jwenn fòs li? Se yon mistè

an plis dwèt li te tankou dwèt yon fanm!



Hi Hi Hi !!!



fè'm soti nan lanp la, e m'a eksplike nou

alò, Sophia, ki riz li ye?



e byen, jisteman, riz la, sè KE PA GENYEN!

men, gen yon trik kanmenm,
pwiske ou menm, ou fè'l
e mwen m'pa kapab!

miskl yo fonksyone gras a INFLI NÈVE.
e la w'ap voye'l nenpòt kòman. You ti kras
ankò, men'w t'ap finen!



Tout bagay se yon kesyon
d'APRANTISAJ

se sa menm!

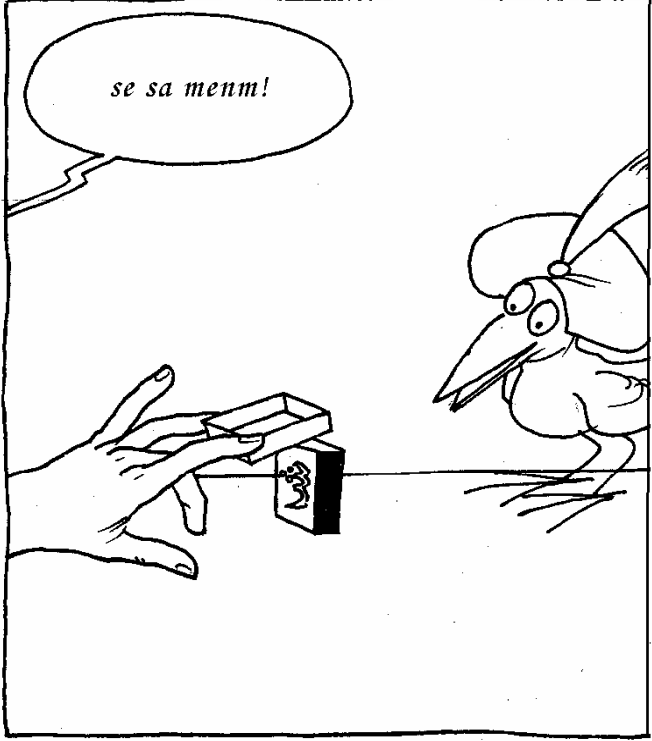

fò'w rive dirije enpilsyon nève yo
nan bon sikwi yo e kòddone aksyon
miskilè yo pou'w reyisi

Mil e Yon Nwit Syantifik Yo





ann wè kisa Schatzmani ap fabrike la
 ki sanble plonje nan de pwoblèm mekanik
 mwen wè yon kòd, yon pouli, de pwa...



o Sultan venere'm nan, eskize'm, men la, m'ap krake. eksperyans sa enposib!

men pwiskè mwen te di'w ke mwen te wè'l nan rèv!

Limyè l'Oryan an, souveren Absurdistan an, se pa yon manb Akademi dè Syans ou bezwen. Se yon psikanalist!.. Mwen prefere demisyone. Mwen jwenn yon pòs de gran enkizitè nan Akademi dè Syans Entegristan an.

cheve'm fin blanchi e yo kòmanse frize akòz de tout pwoblèm sa yo. Mwen gen ase de tout virewon sa yo!..

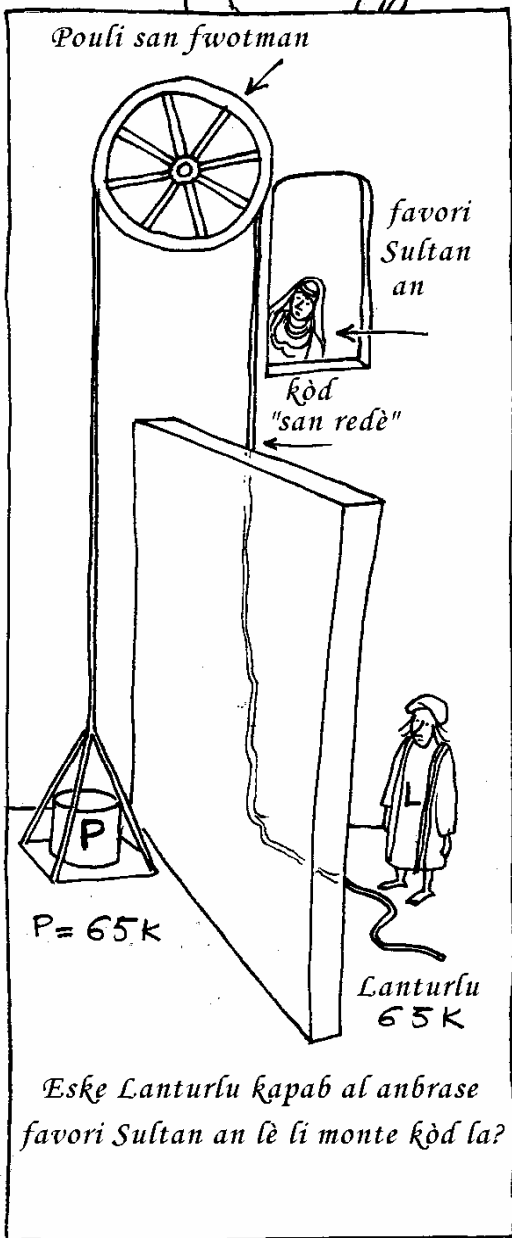

sa konplètman idyo. Si $P > L$, alò Lanturlu ap monte. Si $P < L$, se pwa a k'ap monte. Men si $P = L$ anyen pap pase ditou! Mwen pral devni prezidan Sosyete Entegristanèz fizik la. Isi a se yon kay moun fou!





Schatzmani sa sòt. Ekpéryans
la te prè pou fonksyone e Sultan
an te reve jis

viv
ENTEGRISTAN

kisa'w vle di?

Lanturlu peze 65K, kont-pwa a tou. Lè Anselme egzèse yon traksyon kèlkonk sou kòd la, kòm pouli a pa pwodwi ankenn fwotman fòs la transmèt a pwa e a... li menm, an fonksyon de prensip Aksyon-Reaksyon. Si fòs la enferyè ou egal a pwa a, anyen pa pase. Ni kont-pwa ni Lanturlu pa soulve. Men, dè ke fòs Anselme ap egzèse a siperyè, tou de monte, menm jan, pwiskè yo soumèt a menm fòs la, e ke yo gen menm MAS

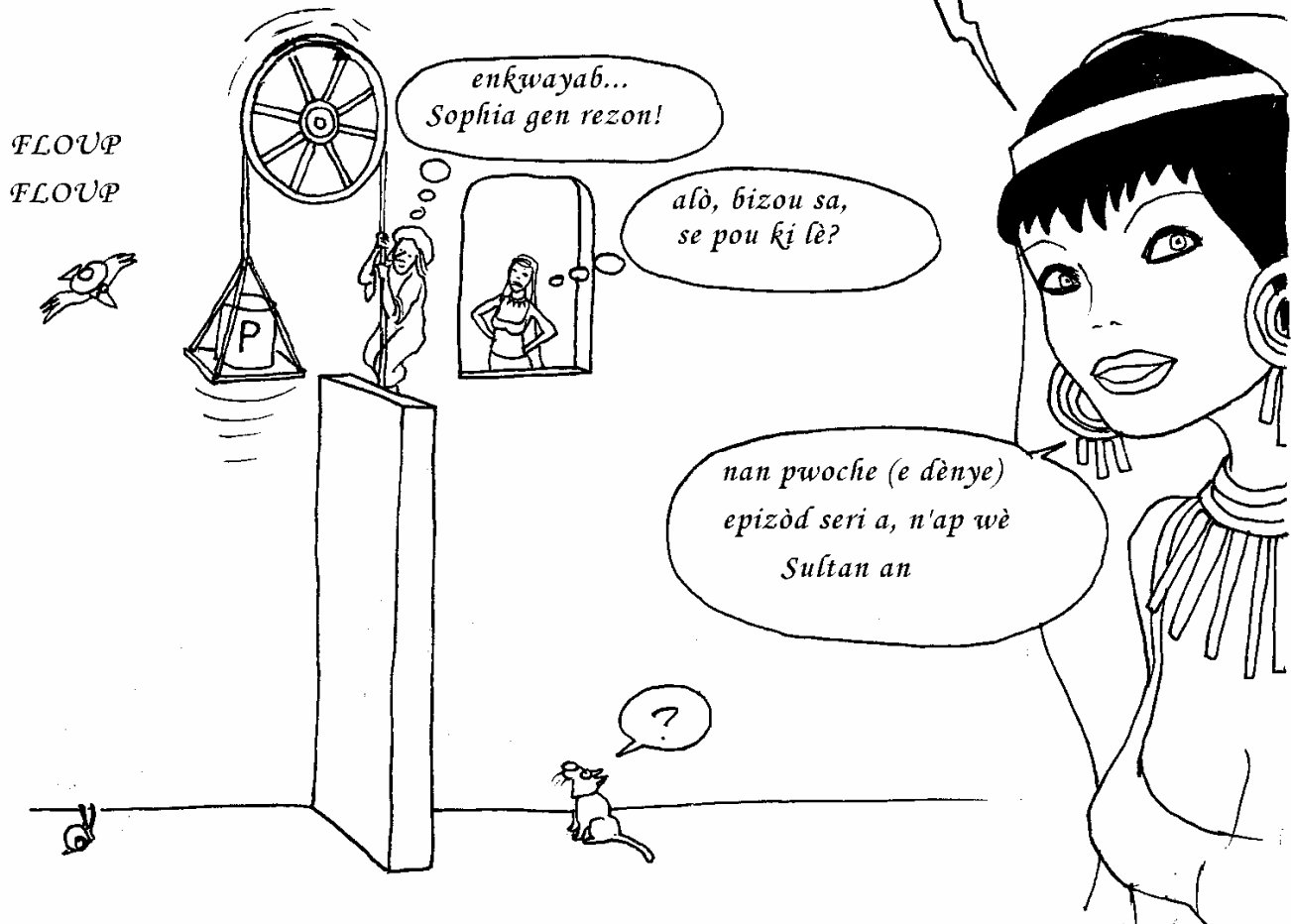

FLOUP
FLOUP

enkwayab...
Sophia gen rezon!

alò, bizou sa,
se pou kij lè?

nan pwoche (e dènye)
epizòd seri a, n'ap wè
Sultan an

?

Mil e Yon Nwit Syantifik Yo

Lannwit tonbe sou rwayòm
ABSURDISTAN an



Schatzmani kite nou. Li nan wout pou ENTEGRISTAN mwen pa gen patron ankò. Men mwen nan chomaj, kounye a

kisa'w vle, pou jan de nèg sa yo lasyans fonksyone tankou yon relijyon. San sètitud, li pèdi



men lasyans, Anselme, se tankou yon miraj nan dezè a

yon miraj?

gade etwal yo nan syèl la. Moun yo te kwè, pandan dè syèk, ke plis yo te briyan plis yo te pwòch. Alò ke etwal ki pi briyan yo se de etwal jèn, ki emèt anpil e pafwa ki trè lwen



tank ou konnen, Sophia

an plis yo te kwè ke etwal yo te nan menm distans ke planèt yo, sa vle di di "a de milyon de lye". Yo te fè tèt yo yon fo lide de kosmos la



alò moun tankou Schatzmani yo te di ke Latè pa't ka bouje, paske, si'l te kapab, etwal ki pi pwòch yo ta dwe deplase, pa efè paralax, pa rapò a etwal ki pi lwen yo

ke yo te akwoche a li pandan trè, trè lontan



yon astwonòm Danwa, Tycho Braché, Braché, te menm montre "pa kalkil" ke lide mouvman Latè a pa't reziste a analiz, paske vout syèl la te... imobil!

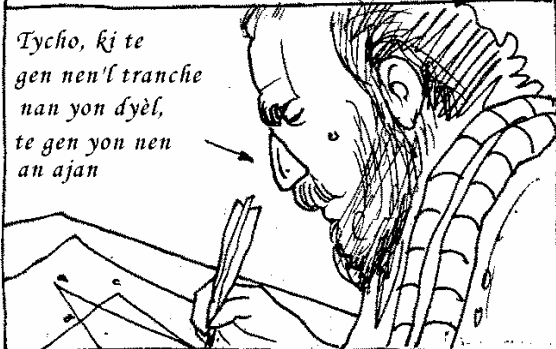

Tycho, ki te gen nen'l tranche nan yon dyèl, te gen yon nen an ajan

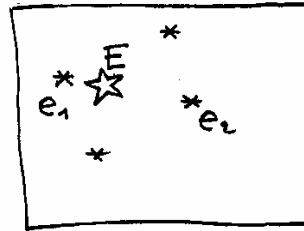
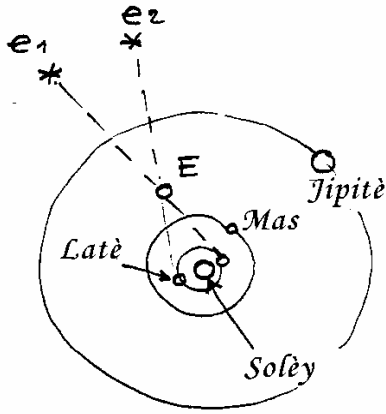

Ète

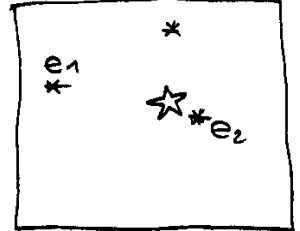

Ivè

Rezònman ki fonde sou fenomèn paralax la: Swa E yon "etwal pwòch" e e_1 , e_2 de etwal lwen. Si Latè ap vire otou de Solèy la etwal pwòch E dwe projete yon lòt jan sou "fon syèl la" (etwal e_1 e e_2) dapre sezon yo



e se sa k'ap pase nan reyalite a. Men Tycho podjab te souzestime ditans etwal yo: Yo DI MIL FWA PI LWEN ke planèt yo. Si sistèm solèy la gen tay yon dinar, etwal ki pi pwòch la li nan limit vil la. Yo te oblije tann dis nevièn syèk e avènman fotografi pou Bessel te ka mete fenomèn sa an evidans



van nan dezè a kòmanse ap soufle vini, ann rantre



o, m'tande Sultan an k'ap vini. Vit, mwen retounen nan lanp la!

kote valè Schatzmani an!?

se mwen, splandè...

